

THE POS EXPERTS.

// Guaranteed strong sales.



OUR **EXPERIENCE** AT THE POINT OF SALE.

Wide range of POS presentations for any shop

// Our **market-approved sales systems** increase the sales density and raise your revenue.

// **Fits perfect. The appropriate sales systems for every space:**
From counter displays up to complete presentation walls.

// Product labels in the **local language**, the comprehensible **colour coding system** and the market-driven display assortment provide optimum and clear presentation at the POS and raise your **revenue**.

Merchandising.

- // From sales counter display up to several meters of presentation walls
- // Increased turnover and profit at the same space guaranteed!
- // Space saving modules
- // Therefore a high range of products but also possible with different quality levels in the shop
- // For use in any specialist store



The brand ALPEN

- // The drill experts for professionals: The right drill for every job and every demand.
- // The only full source provider for drilling tools manufactured in-house.
- // The leading provider of metal, masonry and wood drills.





The perfect shopping result.
*ALPEN adapts the range
to suit customer needs
to ensure shelved products
achieve the best effect.*

NEW

drill better.
ALPEN

SDS-PLUS HAMMER
EPIcenter
F16
★★★★
alpen

SDS-PLUS HAMMER DRILL BITS
alpen

MULTI-PURPOSE DRILL BITS
alpen

PROMOTION

HAMMER DRILL BITS
alpen

SDS-MAX HAMMER DRILL BITS
alpen

MASONRY DRILL BITS
alpen

drill better.
ALPEN

THE PERFECT OFFER.

*Market-approved POS know-how for strong sales.
We have the right display for every available space.*



Ground display
One or two-sided presentation



Drill display
Eye-catching design, perfect secondary placement



Presentation wall
The complete product range at a glance



Metal cabinet
For single drills



Cardboard display
The space-saving solution, ideal for promotion.



Pillar display
Best use of shelf pillars



Counter-display
Space saving. Perfect for product promotions. Suitable for all module variants.



BEST-SELLING MODULES.

Everything clearly packed for fast hanging

- // 30 standardized modules with the established drill assortment, or individual assembly according to customer requirements
- // Suitable in all ALPEN presentation systems as well as in any standard hole wall (width of module 50 cm)
- // Optimum module dimensions: 50 x 70 cm
- // Scope of supply: Products + module rack incl. hooks + product header in national language



Dimensions for every tool

Flexible through to variable hook system

NEW COLORING SYSTEM.

- // Red: Special drill bits (Multicut - Granite - Keramo)
- // Blue: Concrete and masonry drill bits (Long Life - Profi Beton - SDS drill bits)
- // Green: Metal drills (Sprint Master - Super - Pro - Cobalt)
- // Orange: Drills for wood





Advanced product headers for product information in native language



Eye-catcher with customer benefits



Track for pricing



Foldable for double-sided product identification

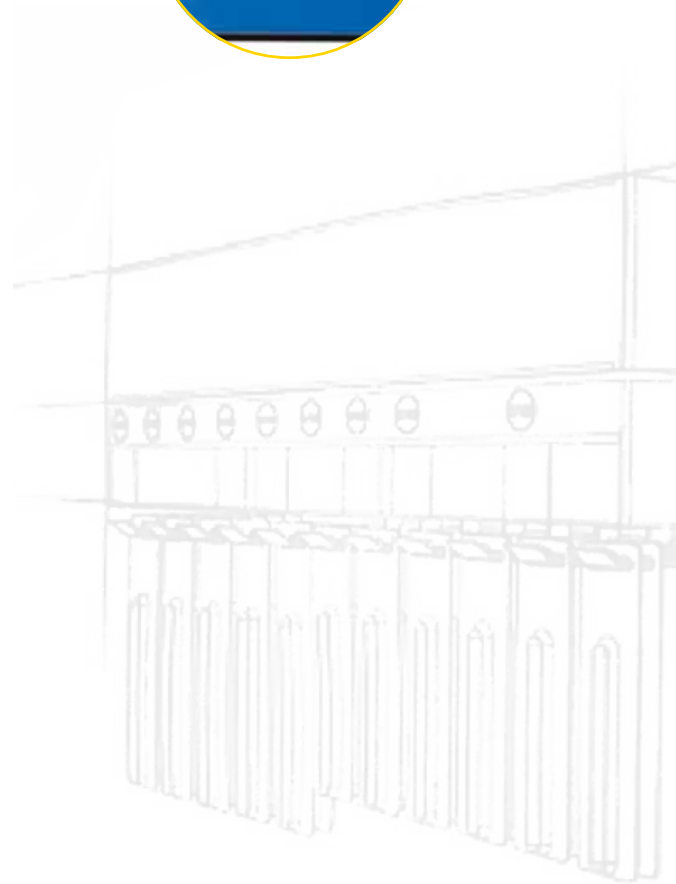





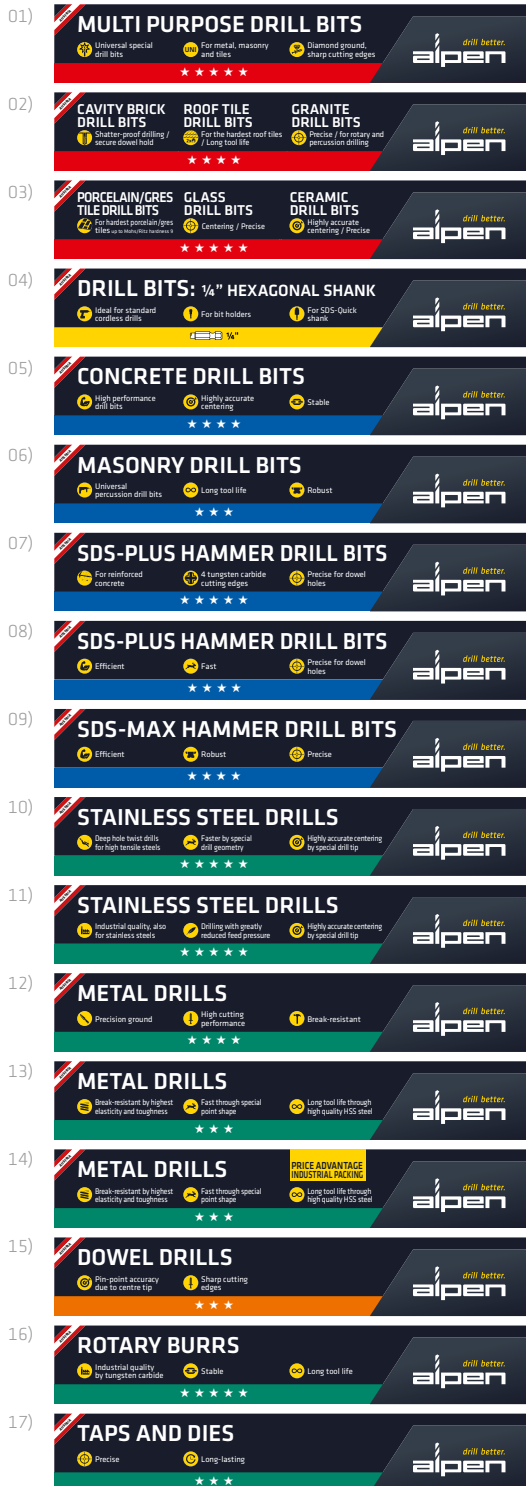

PRODUCT HEADERS IN NATIONAL LANGUAGE.

Significant product information at the POS

PRODUCT HEADERS IN NATIONAL LANGUAGE.





Significant product information at the POS



			
	DE	GB	IT
01)	00 098999061 00	00 098998061 00	00 098997061 00
02)	00 098999081 00	00 098998081 00	00 098997081 00
03)	00 098999101 00	00 098998101 00	00 098997101 00
04)	00 098999231 00	00 098998231 00	00 098997231 00
05)	00 098999041 00	00 098998041 00	00 098997041 00
06)	00 098999051 00	00 098998051 00	00 098997051 00
07)	00 098999021 00	00 098998021 00	00 098997021 00
08)	00 098999011 00	00 098998011 00	00 098997011 00
09)	00 098999031 00	00 098998031 00	00 098997031 00
10)	00 098999181 00	00 098998181 00	00 098997181 00
11)	00 098999171 00	00 098998171 00	00 098997171 00
12)	00 098999151 00	00 098998151 00	00 098997151 00
13)	00 098999131 00	00 098998131 00	00 098997131 00
14)	00 098999141 00	00 098998141 00	00 098997141 00
15)	00 098999111 00	00 098998111 00	00 098997111 00
16)	00 098999201 00	00 098998201 00	00 098997201 00
17)	00 098999211 00	00 098998211 00	00 098997211 00
			
	HU	SI	PL
01)	00 098991061 00	00 098990061 00	00 098989061 00
02)	00 098991081 00	00 098990081 00	00 098989081 00
03)	00 098991101 00	00 098990101 00	00 098989101 00
04)	00 098991231 00	00 098990231 00	00 098989231 00
05)	00 098991041 00	00 098990041 00	00 098989041 00
06)	00 098991051 00	00 098990051 00	00 098989051 00
07)	00 098991021 00	00 098990021 00	00 098989021 00
08)	00 098991011 00	00 098990011 00	00 098989011 00
09)	00 098991031 00	00 098990031 00	00 098989031 00
10)	00 098991181 00	00 098990181 00	00 098989181 00
11)	00 098991171 00	00 098990171 00	00 098989171 00
12)	00 098991151 00	00 098990151 00	00 098989151 00
13)	00 098991131 00	00 098990131 00	00 098989131 00
14)	00 098991141 00	00 098990141 00	00 098989141 00
15)	00 098991111 00	00 098990111 00	00 098989111 00
16)	00 098991201 00	00 098990201 00	00 098989201 00
17)	00 098991211 00	00 098990211 00	00 098989211 00

Additional languages upon request

				
ES	FR	NL	FI	CZ
00 098996061 00	00 098995061 00	00 098994061 00	00 098993061 00	00 098992061 00
00 098996081 00	00 098995081 00	00 098994081 00	00 098993081 00	00 098992081 00
00 098996101 00	00 098995101 00	00 098994101 00	00 098993101 00	00 098992101 00
00 098996231 00	00 098995231 00	00 098994231 00	00 098993231 00	00 098992231 00
00 098996041 00	00 098995041 00	00 098994041 00	00 098993041 00	00 098992041 00
00 098996051 00	00 098995051 00	00 098994051 00	00 098993051 00	00 098992051 00
00 098996021 00	00 098995021 00	00 098994021 00	00 098993021 00	00 098992021 00
00 098996011 00	00 098995011 00	00 098994011 00	00 098993011 00	00 098992011 00
00 098996031 00	00 098995031 00	00 098994031 00	00 098993031 00	00 098992031 00
00 098996181 00	00 098995181 00	00 098994181 00	00 098993181 00	00 098992181 00
00 098996171 00	00 098995171 00	00 098994171 00	00 098993171 00	00 098992171 00
00 098996151 00	00 098995151 00	00 098994151 00	00 098993151 00	00 098992151 00
00 098996131 00	00 098995131 00	00 098994131 00	00 098993131 00	00 098992131 00
00 098996141 00	00 098995141 00	00 098994141 00	00 098993141 00	00 098992141 00
00 098996111 00	00 098995111 00	00 098994111 00	00 098993111 00	00 098992111 00
00 098996201 00	00 098995201 00	00 098994201 00	00 098993201 00	00 098992201 00
00 098996211 00	00 098995211 00	00 098994211 00	00 098993211 00	00 098992211 00

				
RU	SK	RO	IL	HR
00 098988061 00	00 098987061 00	00 098986061 00	00 098985061 00	00 098984061 00
00 098988081 00	00 098987081 00	00 098986081 00	00 098985081 00	00 098984081 00
00 098988101 00	00 098987101 00	00 098986101 00	00 098985101 00	00 098984101 00
00 098988231 00	00 098987231 00	00 098986231 00	00 098985231 00	00 098984231 00
00 098988041 00	00 098987041 00	00 098986041 00	00 098985041 00	00 098984041 00
00 098988051 00	00 098987051 00	00 098986051 00	00 098985051 00	00 098984051 00
00 098988021 00	00 098987021 00	00 098986021 00	00 098985021 00	00 098984021 00
00 098988011 00	00 098987011 00	00 098986011 00	00 098985011 00	00 098984011 00
00 098988031 00	00 098987031 00	00 098986031 00	00 098985031 00	00 098984031 00
00 098988181 00	00 098987181 00	00 098986181 00	00 098985181 00	00 098984181 00
00 098988171 00	00 098987171 00	00 098986171 00	00 098985171 00	00 098984171 00
00 098988151 00	00 098987151 00	00 098986151 00	00 098985151 00	00 098984151 00
00 098988131 00	00 098987131 00	00 098986131 00	00 098985131 00	00 098984131 00
00 098988141 00	00 098987141 00	00 098986141 00	00 098985141 00	00 098984141 00
00 098988111 00	00 098987111 00	00 098986111 00	00 098985111 00	00 098984111 00
00 098988201 00	00 098987201 00	00 098986201 00	00 098985201 00	00 098984201 00
00 098988211 00	00 098987211 00	00 098986211 00	00 098985211 00	00 098984211 00

SPARE PARTS LIST MODULE.

Everything clearly packed for fast hanging

MODULE RACK

Dimensions (DxH): 50 x 41 cm

Art.-No. 1-row (without drills)
0009890017100

Art.-No. 2-row (without drills)
0009890018100

Diameter sticker round A4 sheet

Sheet 1/5 // Art.-No.: 0009890032100
Sheet 2/5 // Art.-No.: 0009890033100
Sheet 3/5 // Art.-No.: 0009890034100
Sheet 4/5 // Art.-No.: 0009890035100
Sheet 5/5 // Art.-No.: 0009890036100

Hook, single

Art.-No.: 0009890021100

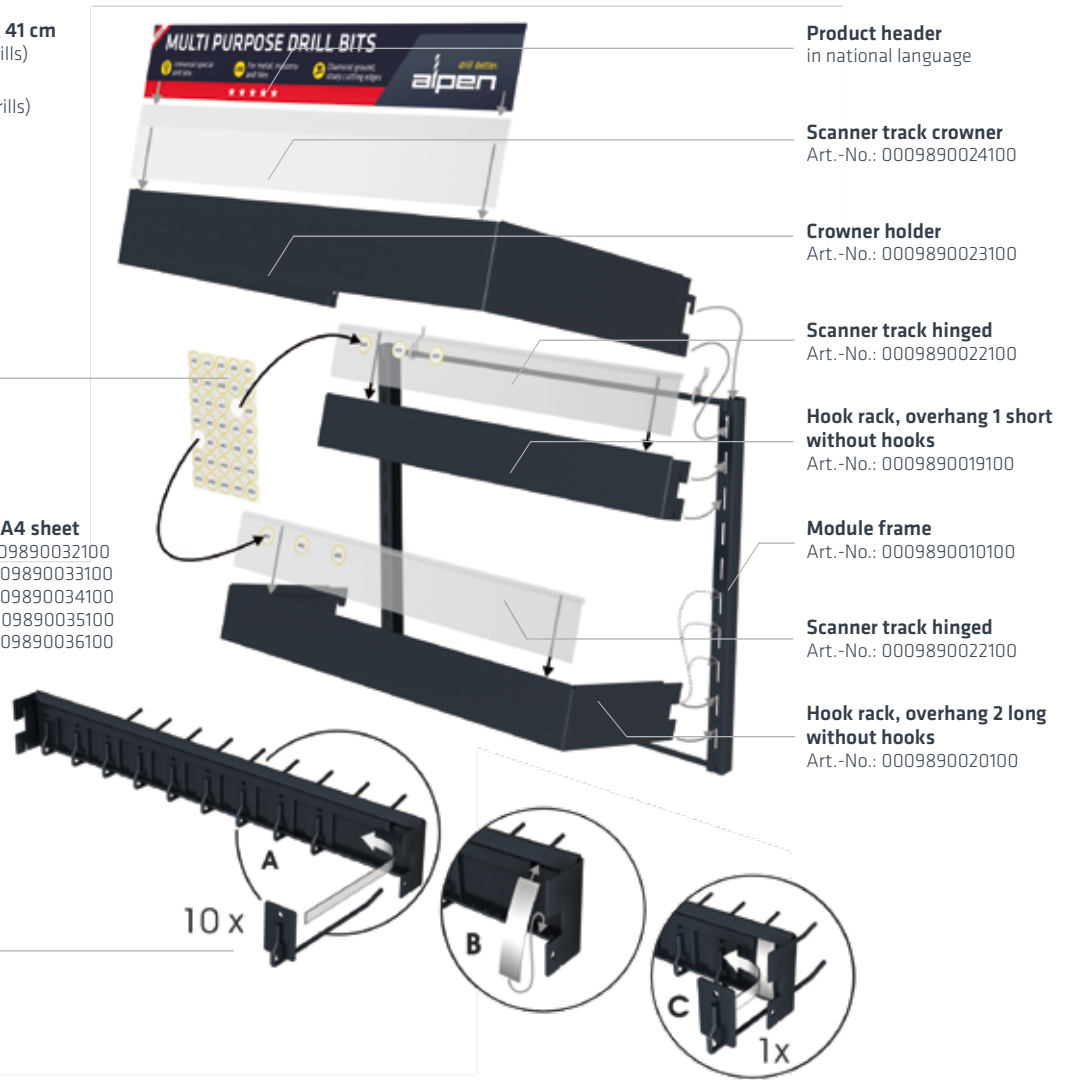

INSTALLING THE CROWNER.



LOCKABLE CABINET.

For easy hanging into
the perforated wall.



ORDER LIST CABINET.



Diameter sticker round A4 sheet
 Sheet 1/5 // Art.-No.: 0009890032100
 Sheet 2/5 // Art.-No.: 0009890033100
 Sheet 3/5 // Art.-No.: 0009890034100
 Sheet 4/5 // Art.-No.: 0009890035100
 Sheet 5/5 // Art.-No.: 0009890036100

Hook single
 Art.-No.: 0009890021100

Crowner: Version ALPEN
 Art.-No.: 0009899928100

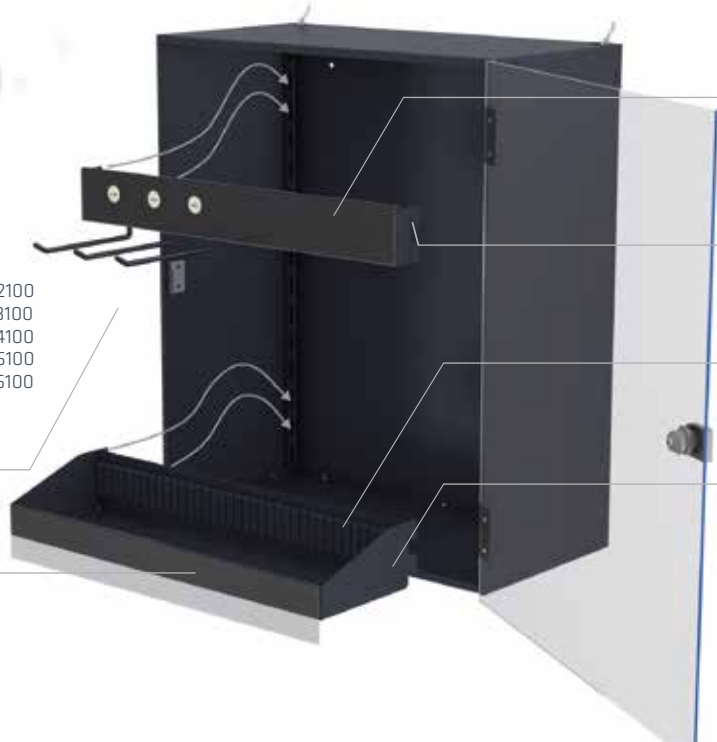

Scanner track hinged
 Art.-No.: 0009890022100

**Hook rack, overhang 1 short
without hooks**
 Art.-No.: 0009890019100

Box separation short
 Art.-No.: 0009890014100

**Box short, 117mm incl.
scanner track hinged**
 Art.-No.: 0009890011100

Version ALPEN-MAYKESTAG
 Art.-No.: 0009899929100



CABINET
 (without drills and
boxes)
 Art.-No.: 0009890037100

INNOVATIVE INDUSTRIAL PACKING MODULE.

*Special module for all packagings
without tag*



ORDER LIST INDUSTRIAL PACKING.



Diameter sticker round A4 sheet
 Sheet 1/5 // Art.-No.: 0009890032100
 Sheet 2/5 // Art.-No.: 0009890033100
 Sheet 3/5 // Art.-No.: 0009890034100
 Sheet 4/5 // Art.-No.: 0009890035100
 Sheet 5/5 // Art.-No.: 0009890036100

Crowner: Version ALPEN
 Art.-No.: 0009899928100



Version: ALPEN-MAYKESTAG
 Art.-No.: 0009899929100

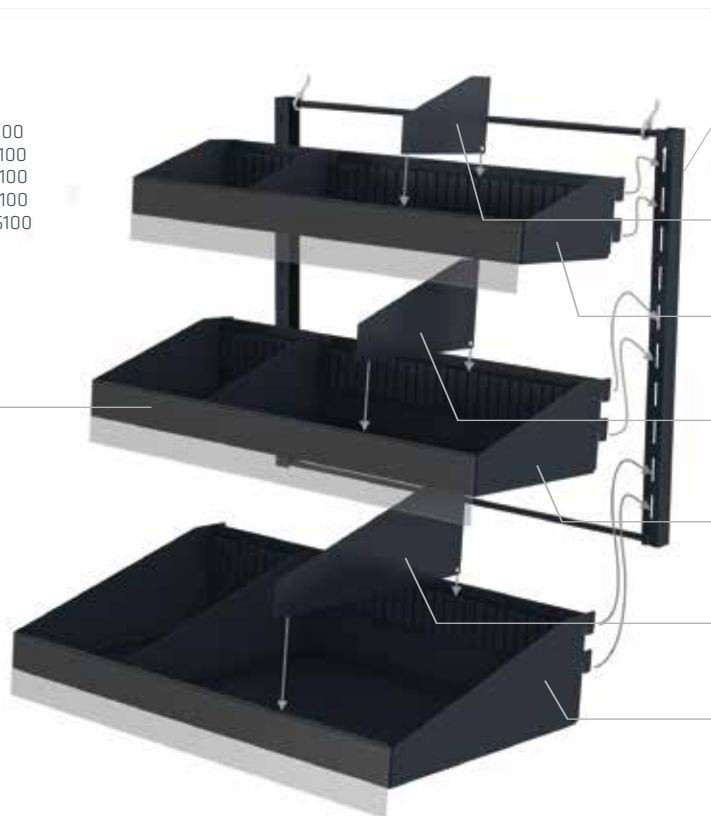

INDIVIDUAL ASSEMBLY.

Ø mm	l1 mm	Art.-No.	pc.
1,0	34	00 954001001 00	20
1,5	40	00 954001501 00	20
2,0	49	00 954002001 00	20
2,5	57	00 954002501 00	20
3,0	61	00 954003001 00	30
3,3	65	00 954003301 00	10
3,5	70	00 954003501 00	20
4,0	75	00 954004001 00	30
4,2	75	00 954004201 00	20
4,5	80	00 954004501 00	30
5,0	86	00 954005001 00	20
5,5	93	00 954005501 00	10
6,0	93	00 954006001 00	20
6,5	101	00 954006501 00	10
6,8	109	00 954006801 00	10
7,0	109	00 954007001 00	20
7,5	109	00 954007501 00	10
8,0	117	00 954008001 00	20
8,5	117	00 954008501 00	10
9,0	125	00 954009001 00	10
9,5	125	00 954009501 00	10
10,0	133	00 954010001 00	10
10,2	133	00 954010201 00	5
10,5	133	00 954010501 00	5
11,0	142	00 954011001 00	5
11,5	142	00 954011501 00	5
12,0	151	00 954012001 00	5
12,5	151	00 954012501 00	5
13,0	151	00 954013001 00	5

ASSEMBLY VARIANT: VM29 FOR METAL DRILLS

- 3x Crouner ALPEN // Art.-No.: 0009899928100
- 1x Module frame // Art.-No.: 0009890010100
- 9x Box separation short // Art.-No.: 0009890014100
- 1x Box short, 117 mm incl. scanner track hinged // Art.-No.: 0009890011100
- 7x Box separation medium // Art.-No.: 0009890015100
- 1x Box medium, 167 mm incl. scanner track hinged // Art.-No.: 0009890012100
- 10x Box separation long // Art.-No.: 0009890016100
- 1x Box long, 276 mm incl. scanner track hinged // Art.-No.: 0009890013100



Module frame
Art.-No.: 0009890010100

Box separation short
Art.-No.: 0009890014100

Box short, 117mm incl. scanner track hinged
Art.-No.: 0009890011100

Box separation medium
Art.-No.: 0009890015100

Box medium, 167mm incl. scanner track hinged
Art.-No.: 0009890012100

Box separation long
Art.-No.: 0009890016100

Box long, 276mm incl. scanner track hinged
Art.-No.: 0009890013100

FURTHER ASSEMBLY OPTIONS:

SDS-plus drill bits in industrial packing
Drill bits L 110 (Box short 117 mm)
Drill bits L 160 (Box medium 167 mm)
Drill bits L 210 + 260 (Box long 276 mm)

Suitable for MAYKESTAG articles without tag e.g. Taps, HSS Morse taper shank drills, rotary burrs and much more.



COUNTER-DISPLAY.

- // Perfect for product promotions
- // Space saving, fits on any counter
- // Suitable for all modules
- // Dimensions: 50x41x68 cm

COUNTER-DISPLAY

without module and drills
Art.-No.: 0009890029100



CARDBOARD-DISPLAYS.

- // Perfect for cassette promotions
- // Space saving, fits on any counter
- // Suitable for all ALPEN cassettes narrow and wide
- // In different languages and individual assembly
- // Dimensions: 33x35x35cm

METAL-CABINET VM29.

- // Perfect for the sale of single drills
- // Dimensions \varnothing 1-13 x 0.5 mm as well as \varnothing 3.3-4.2-6.8-10.2 mm
- // Space saving, fits on any counter
- // Dimensions: 37x19x23 cm

METAL-CABINET

without drills
Art.-No.: 0009809010100



PILLAR-DISPLAY.

- // Suitable for any pillar, trapeze-perforated plate
- // Space saving
- // Dimension trapeze-perforated plate: 18x6cmx100cm, 18x6cmx140cm



PILLAR-DISPLAY

1.0m length, without drills
Art.-No.: 0009890027100

1.4m length, without drills
Art.-No.: 0009890028100



Option foot extension
(for two-sided presentation)



GROUND - DISPLAY.

- // Fits in any shop
- // 1-sided (3 modules)
- // double-sided (6 modules) presentation
- // Dimensions: 51x47x235 cm



GROUND-DISPLAY

Ground-display
Art.-No.: 0009890030100

foot extension
Art.-No.: 0009890031100

DRILL-DISPLAY.

- // Perfect secondary placement
- // Eye catcher: flashy design cater for a high attention
- // All in all 22 hooks for your assembly of ALPEN cassettes
- // Height 2 m, socket Ø 50 cm



DRILL-DISPLAY

Including double hooks,
without drills
Art.-No.: 0009800061100

DRILL PRESENTATION ON THE WALL.

*Perfect and clearly arranged presentation.
Selection from the complete product range.*



Presentation wall



CONCISE BRAND RECOGNITION.

Long range effect, concise brand recognition.



Perfect overview due to colour coded system.



Shelf stopper for extra attention.



Unique Good-Better-Best system. Space-saving product presentation with up to three different quality levels.

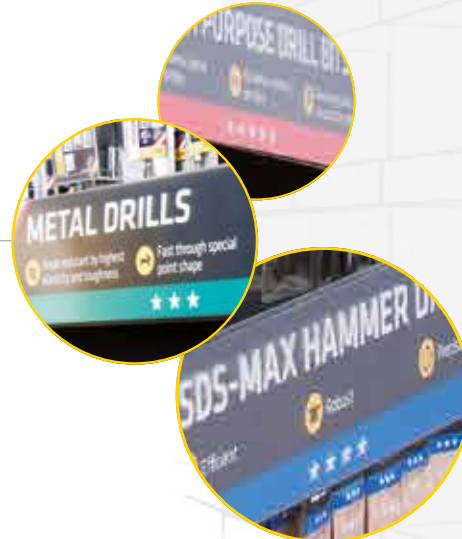

Special module for industrial packing.



ORDER LIST

WALL ELEMENTS.

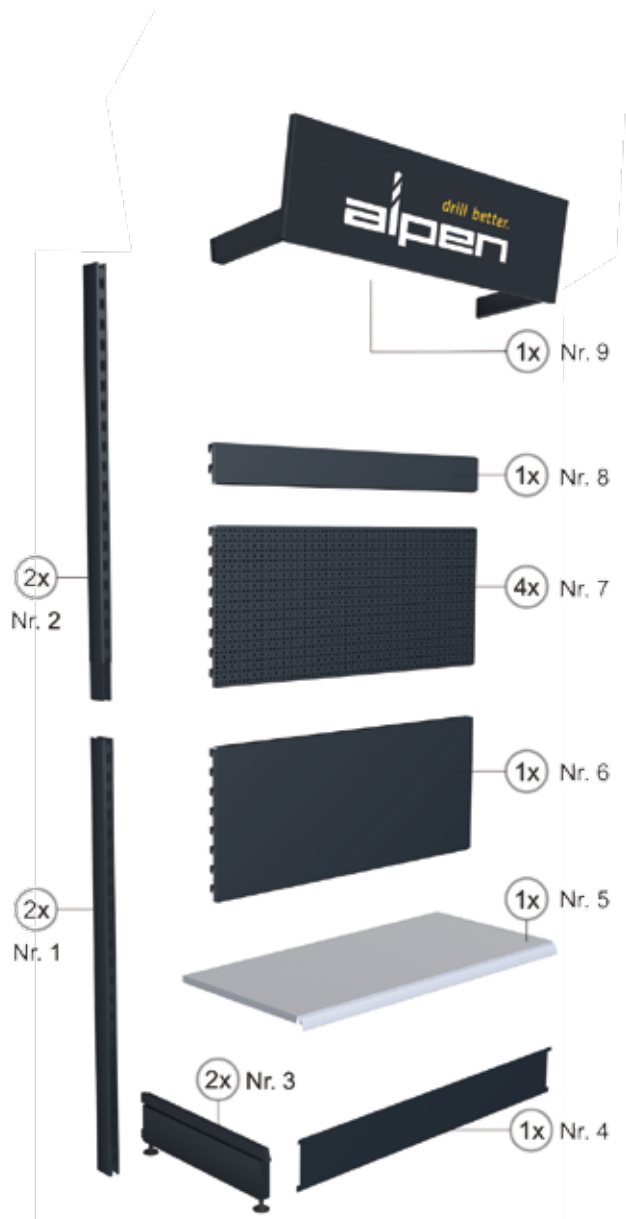

	Art.-No.:	Required quantity			
		1m	2m	3m	4m
Nr. 1: Pillar (60x30x1.200mm)	0009890001100	2	3	4	5
Nr. 2: Pillar extension (60x30x1.000mm)	0009890002100	2	3	4	5
Nr. 3: Foot part (160x470mm)	0009890003100	2	3	4	5
Nr. 4: Front base (1.000x160mm)	0009890005100	1	2	3	4
Nr. 5: Ground panel (1.000x470mm)	0009890004100	1	2	3	4
Nr. 6: Back wall smooth (1.000x400mm)	0009890007100	1	2	3	4
Nr. 7: Back wall perforated (1.000x400mm)	0009890006100	4	8	12	16
Nr. 8: Back wall smooth (1.000x100mm)	0009890008100	1	2	3	4
Nr. 9: Brand header (1.000x300mm)	0009890009100	1	2	3	4



drill better.
alpen

drill better.
alpen

STAINLESS STEEL DRILLS

ROTARY BURRS

DRILL BITS: 1/4" HEXAGONAL SHANK

Perfect presentation at POS.

STAINLESS STEEL DRILLS

METAL DRILLS

METAL DRILLS

NEW

PZ

NEW

DOWEL DRILLS

DOWEL DRILLS

METAL DRILLS

METAL DRILLS

ASSEMBLY INSTRUCTION.

Hanging on the crowner holder

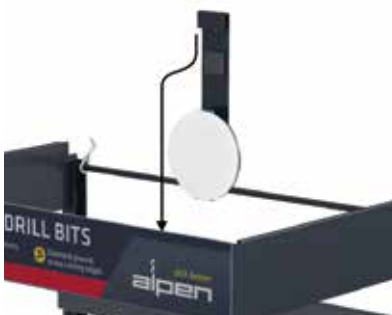

Front shelf stopper
Art.-No.: 0009890025100

SIDE & FRONT SHELF STOPPER.

- // Eye-catcher and perfect information transfer
- // Side and front design
- // Easy assembling in the module
- // Selection options for printed paper stopper



Art.-No.: 0009890038100



Art.-No.: 0009890039100



Art.-No.: 0009890040100



Art.-No.: 0009890041100



Art.-No.: 0009890042100



Art.-No.: 0009890043100



Art.-No.: 0009890044100



Art.-No.: 0009890046100



Art.-No.: 0009890045100



Art.-No.: 0009890048100



Art.-No.: 0009890047100



Art.-No.: 0009890050100



Art.-No.: 0009890049100



Art.-No.: 0009890052100



Art.-No.: 0009890051100



Art.-No.: 0009890054100



Art.-No.: 0009890053100

ASSEMBLY INSTRUCTION.

Hanging right on the crowner holder

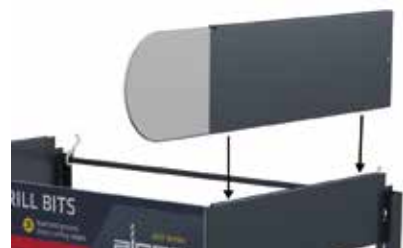

Side shelf stopper
Art.-No.: 0009890026100

Label space & colour guide system

For fast orientation

Safety notes

Clear presentation

Colour guide system & product name

For clear differentiation and simple navigation

Quality system

Each product bears a quality mark of up to 5 stars

Product

Transparent packaging allows a clear view of the product

Infobox

Product details

Material background

Concise usage information at a glance



Plastic wallet

Self-Explanatory packaging

The color coding system, different quality levels, information graphics and an unambiguous assignment of the application provide clarity and understanding at the POS.



Quality levels for every demand

The quality is identifiable by the number of stars.

★★★
Good quality

★★★★
Better quality

★★★★★
Best quality



ALL INFORMATION AT A GLANCE.

Whatever you need to know. Our innovative packaging design keeps you well-informed.

// Simplified selection and a clear presence at the POS. Our packaging and versatile POS placement options stand out through an appealing design, high functionality and also through excellent environmental compatibility.

The labels are unremovable and the plastic wallets are sealed and theft-proof. A colour-coded navigation system, different quality grades, informative illustrations and an unambiguous allocation to the area of use provide clear and comprehensible information at the POS.

Cassettes

Our range also includes a broad selection of sets and cassette options to cover our customers' varying requirements.



Metal cassettes



Plastic box



Plastic cassettes



Plastic tag



Round box



Industrial packing



Mix packs

NUMEROUS CASSETTE-OPTIONS.

// We offer a broad selection of sets and cassette options to cover our customers' varying requirements.



COHERENT POS-PRESENTATION.

- // Coherent packaging design at the POS
- // Color coded & material-motive related system with fast correlation
- // Self-explanatory appearance

Anti-theft protection

Easy remove of the drills

Functional and state-of-the-art design

Respective material motive



ANTI-THEFT SYSTEM PLASTIC CASSETTES.

Front and back side with anti-theft system



POS KNOW HOW OF ALPEN.

Increase of turnover and profit at the same space.

- // Due to the assortment of quality levels and types for different materials the customer has the choice to decide!
- // Thereby the customer decides very often for a better quality
- // ... that's why we create higher turnovers and profits for all at the Point of Sale

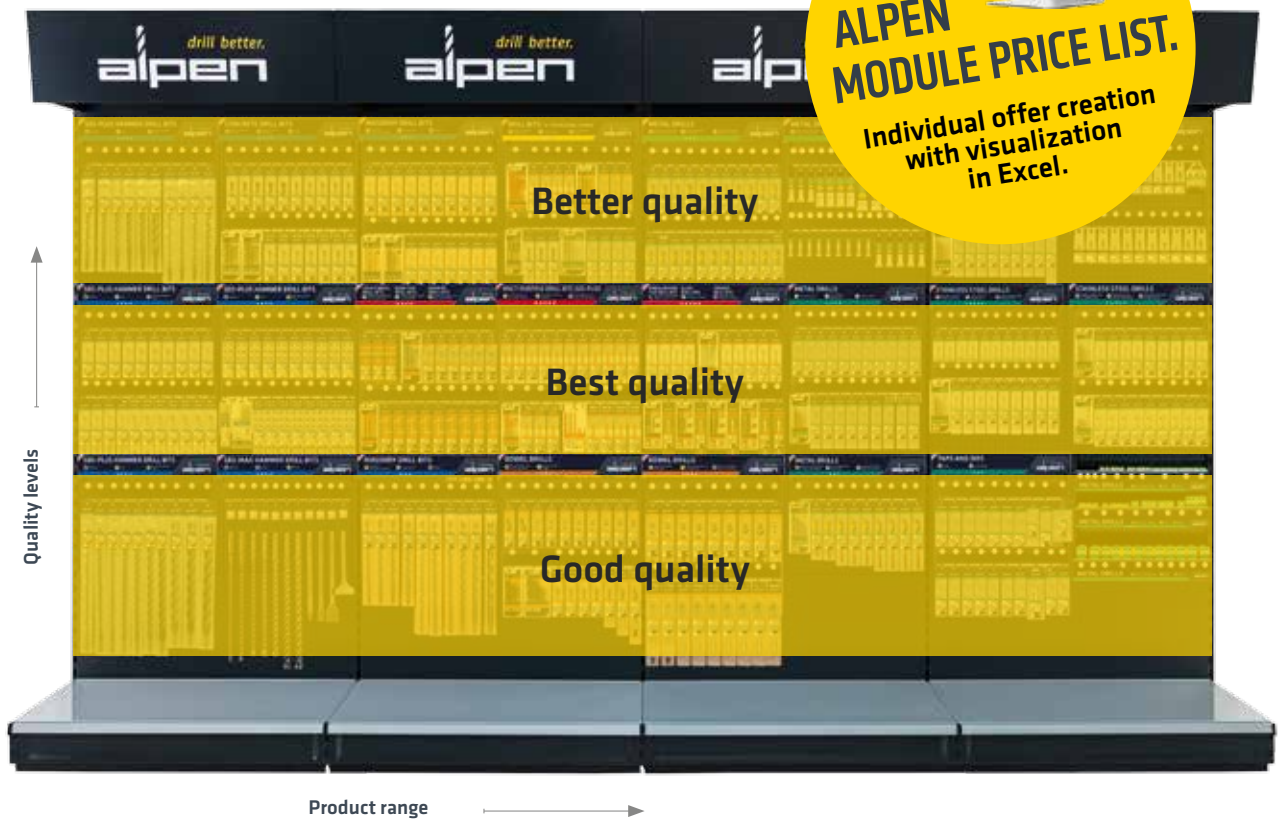

GUARANTEED STRONG SALES.



Unmixed presentation

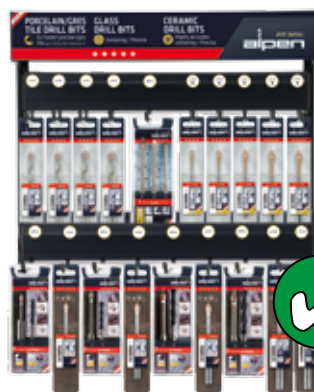

Same application presentation



Special hexagonal shank presentation

DO'S AND DON'TS.

// Placement of the different qualities



// Placement of the shelf stopper



// Continuous placement of the colour system

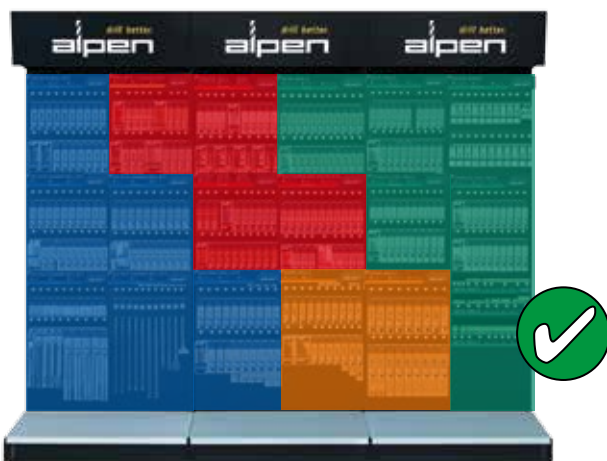

// Sticking the dimensions

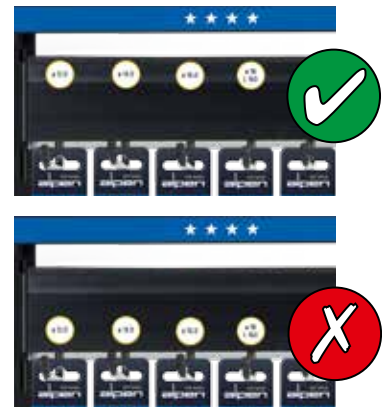

// Individual assembly



Long drills at the back / Short drills at the front

// Pricing and barcode



THE EXPERTS IN DRILLING.

*// Professional presentation of the
ALPEN brand in the premium segment*



THE COMPLETE SUPPLIER.

// Assortment competence / Made in Austria



THE SELLING EXPERTS.

*// Significant increase of your
turnover and profit*



THE EXPERTS IN DRILLING.

*// Professional presentation of the
ALPEN brand in the premium segment*



THE COMPLETE SUPPLIER.

// Assortment competence / Made in Austria



THE SELLING EXPERTS.

*// Significant increase of your
turnover and profit*





English
Art. No.: 0099900151100

With the compliments of:

ÖSTERREICH

ALPEN-MAYKESTAG GmbH

Urstein Nord 67 | A-5412 Puch / Salzburg

Tel: +43 (0) 662 449 01-0

Fax: +43 (0) 662 449 01-110

Fax Export: +43 (0) 662 449 01-130

verkauf@a-mk.com

export@a-mk.com

DEUTSCHLAND

ALPEN-MAYKESTAG GmbH

Hansaallee 201 | D-40549 Düsseldorf

Tel: +49 (0) 211 53 75 50-0

Fax: +49 (0) 211 59 35 73

verkauf@a-mk.com

ITALIA

ALPEN-MAYKESTAG s.r.l.

Via Volontari Del Sangue 54 | I-20093 Cologno Monzese (MI)

Tel: +39 (02) 48 84 30 38

Fax: +39 (02) 45 70 14 19

info@a-mk.it

ČESKÁ REPUBLIKA

ALPEN-MAYKESTAG s.r.o.

U Koruny 414 | CZ-50002 Hradec Králové

Tel. +420 495 58 23 22

Fax +420 495 58 23 25

info@a-mk.cz

MAGYARORSZÁG

ALPEN-MAYKESTAG Kft.

Cyár utca 5 | H-8500 Pápa

Tel. +36 (0) 89 51 15 15

Fax +36 (0) 89 51 15 16

info@a-mk.hu

www.alpen-drills.com